

OZONE

**AC PWR CNTL
DC PWR CNTL**

DC - DC PWR

DRUM

CO2 FIXED PUMP CONTROLS

PILS

CPC

SEMS

**PID
UMAC
LAN + KVM
RS232
COMPUTER**



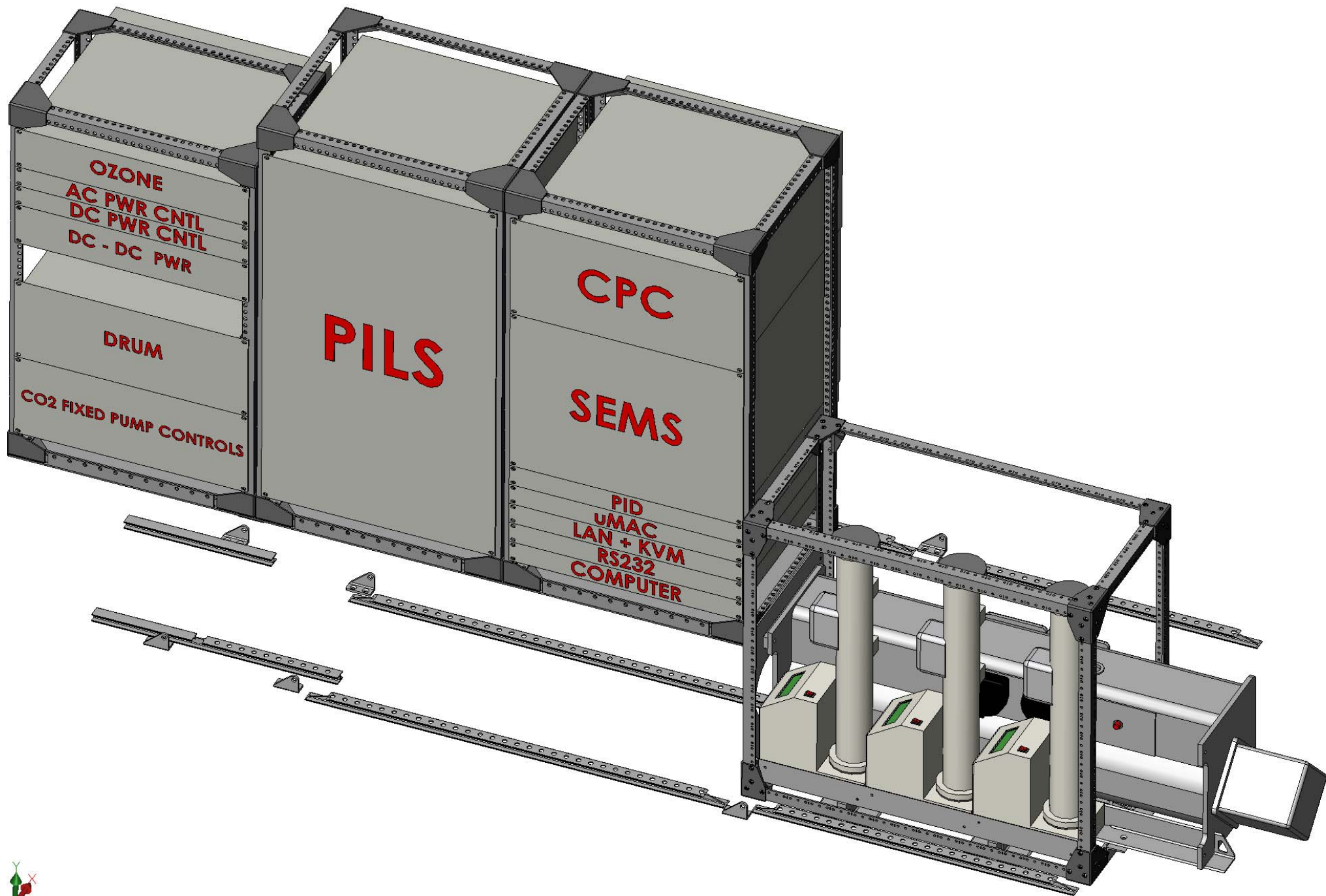

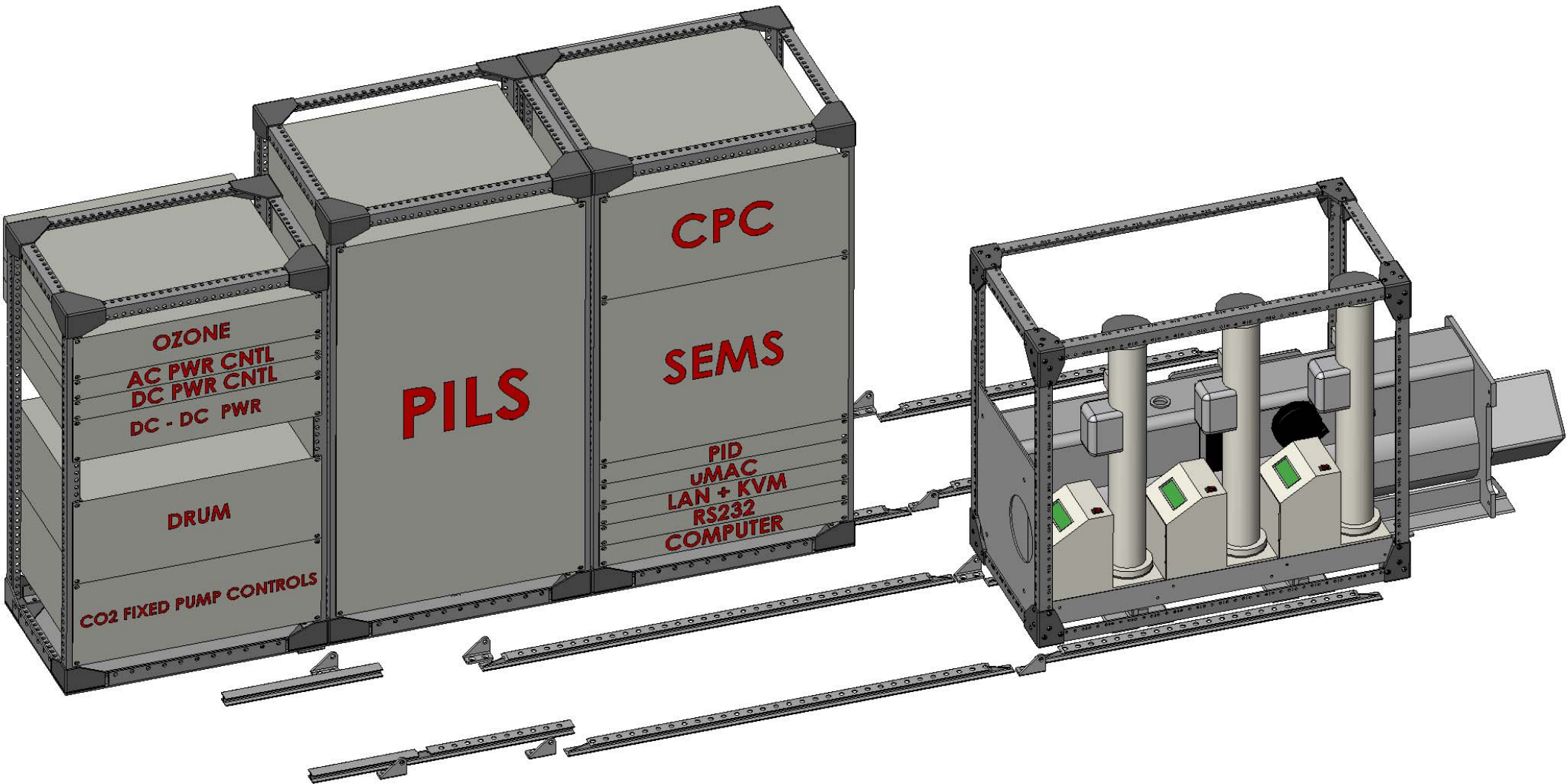

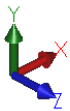

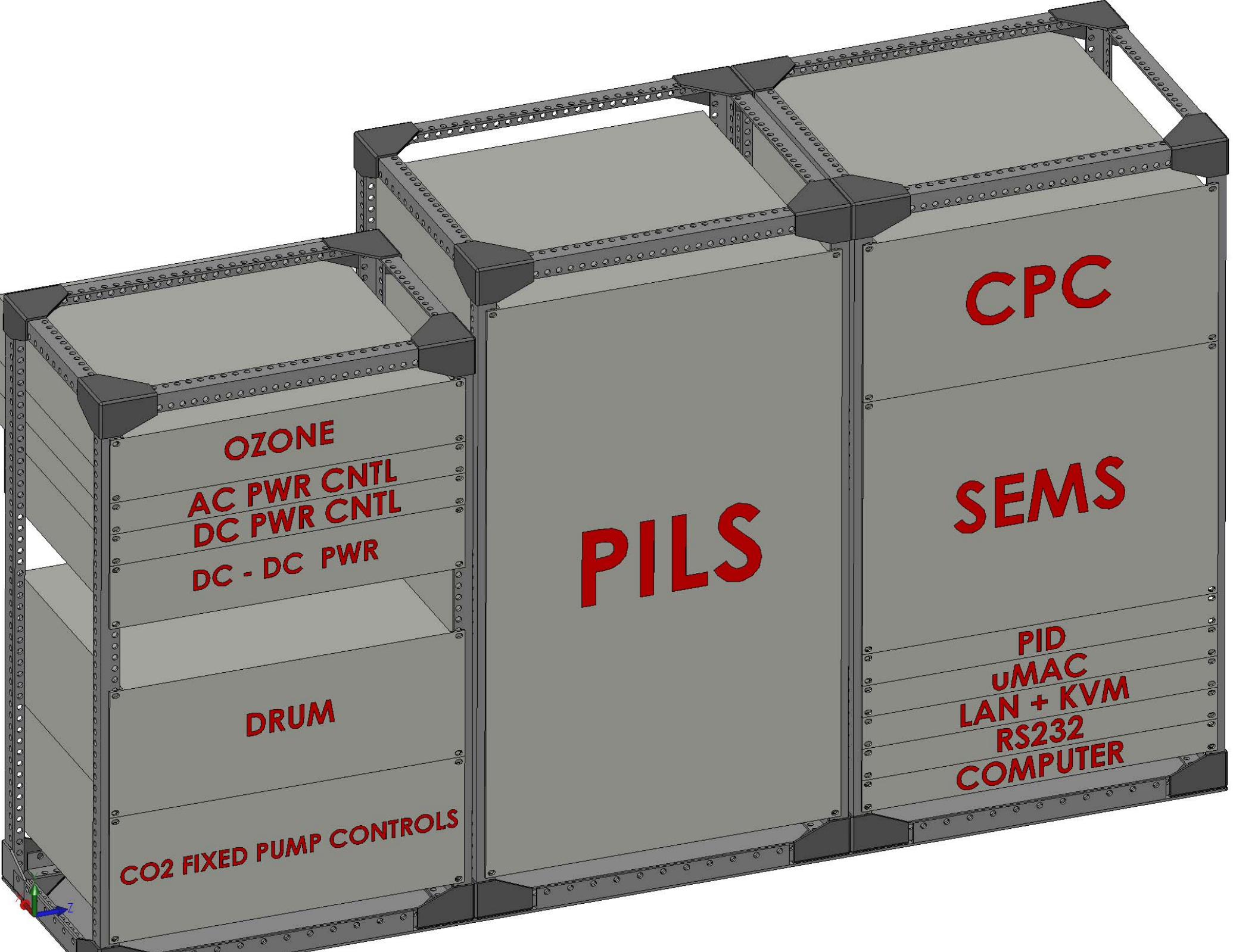

OZONE

AC PWR CNTL
DC PWR CNTL
DC - DC PWR

DRUM

CO2 FIXED PUMP CONTROLS

PILS

CPC

SEMS

PID
UMAC
LAN + KVM
RS232
COMPUTER

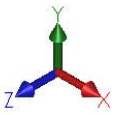
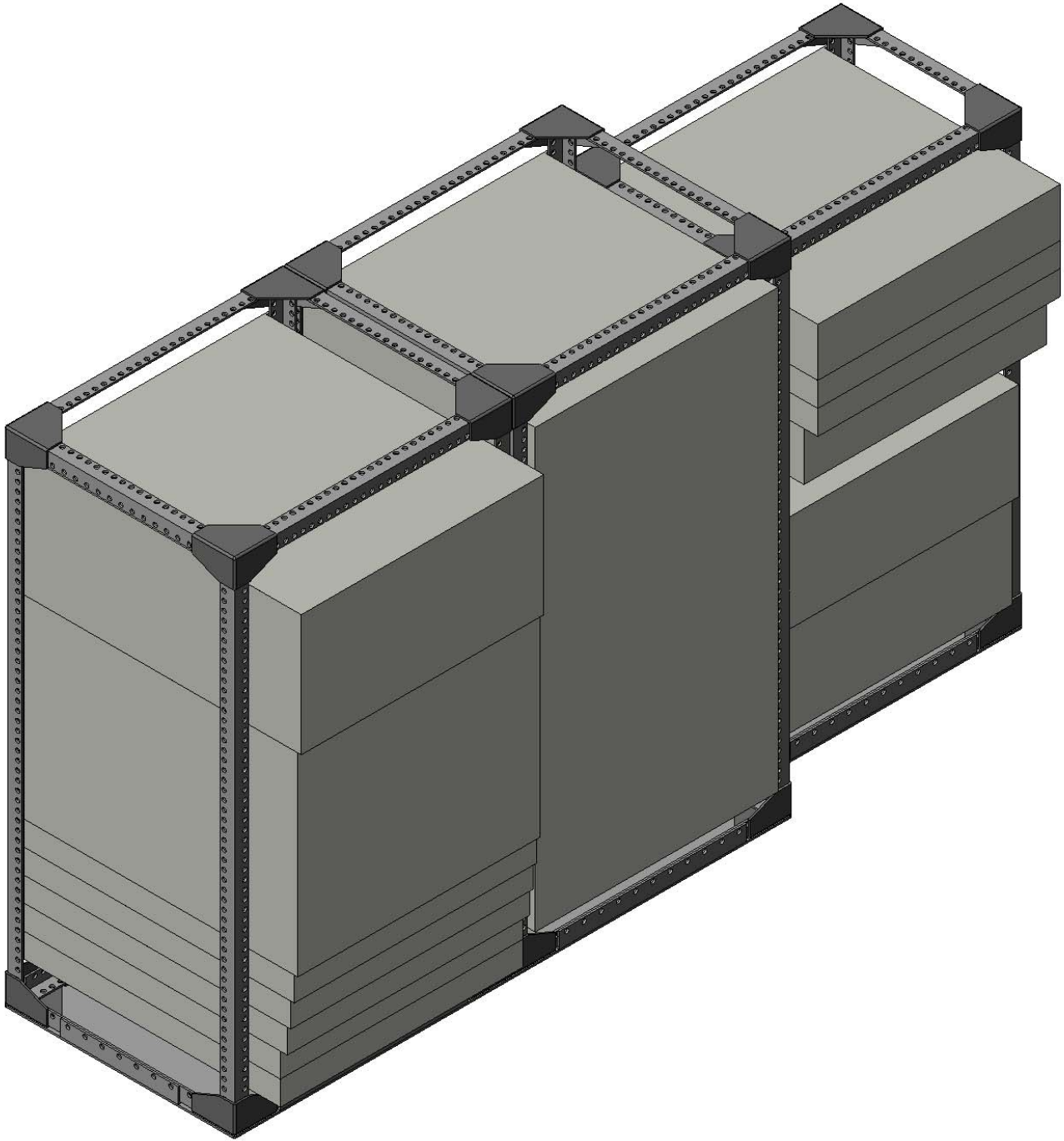

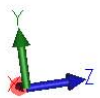
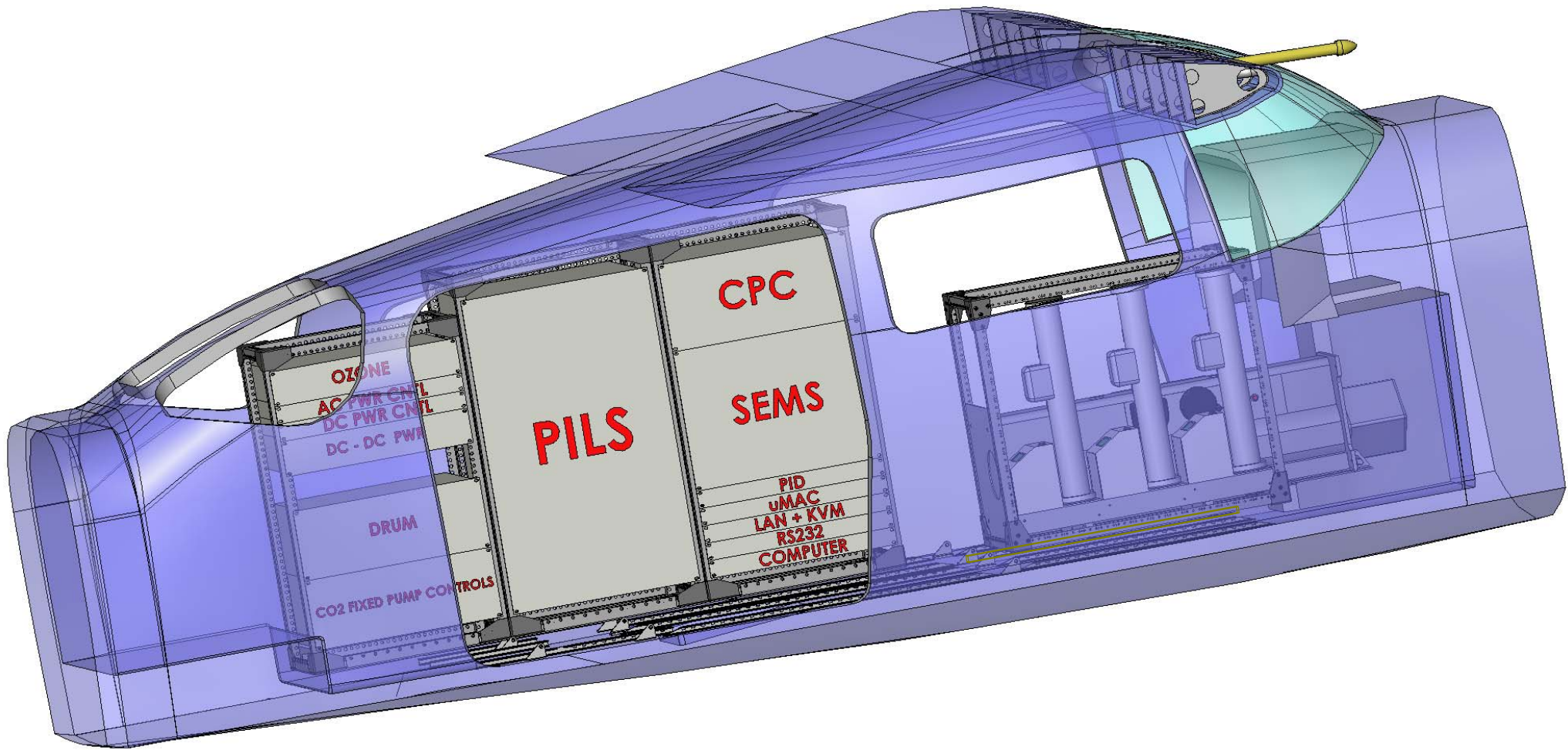

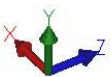
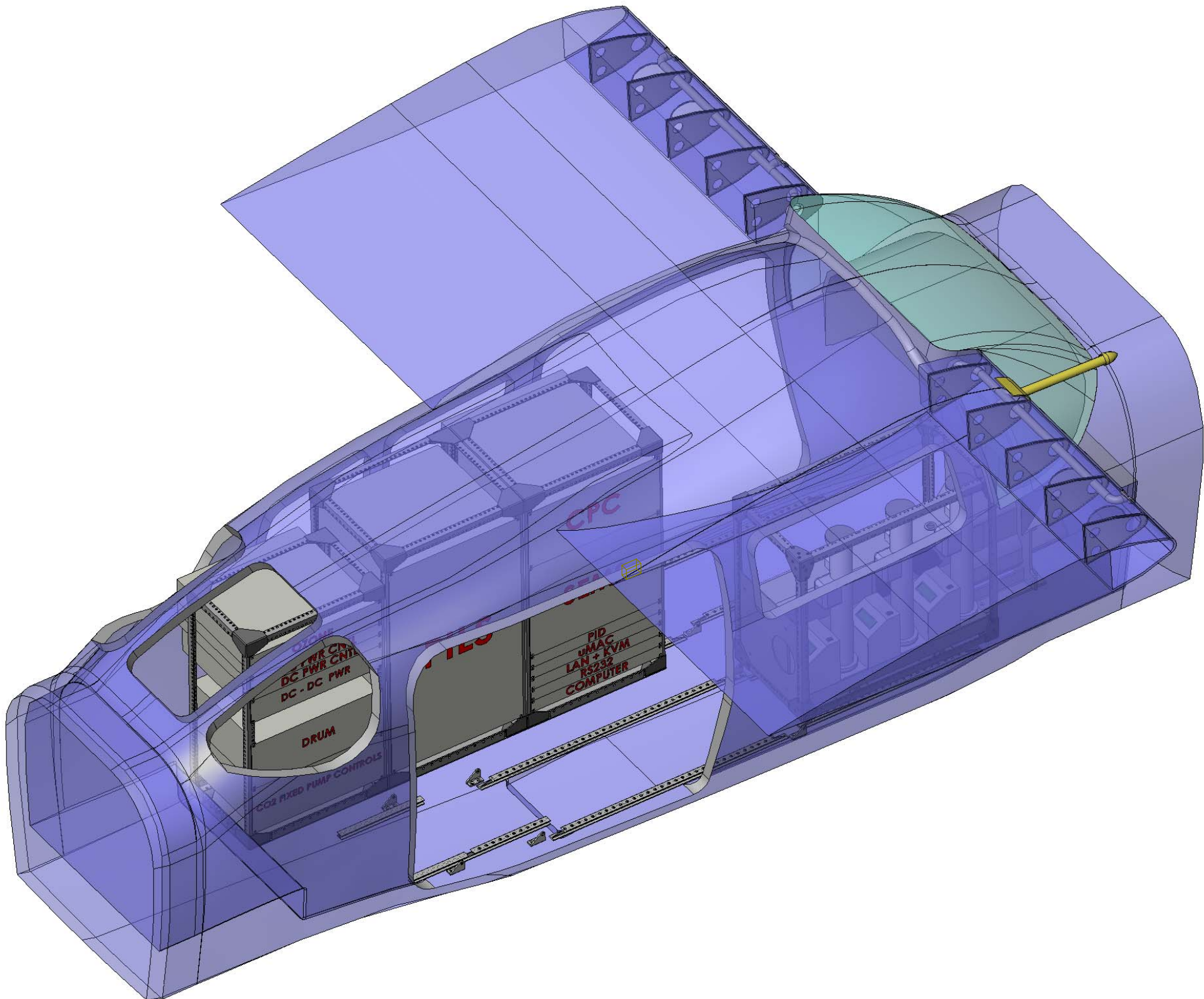

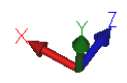
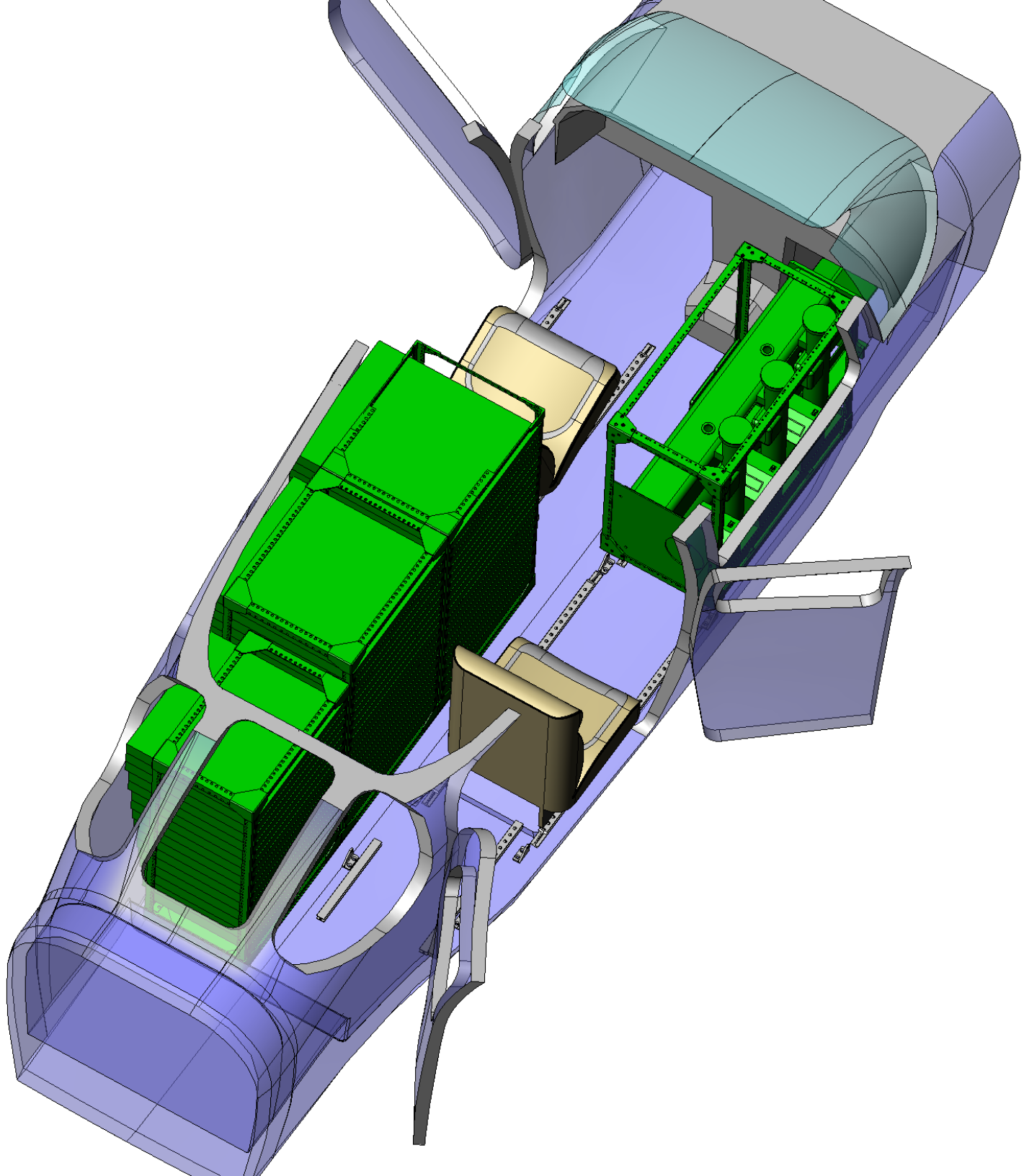

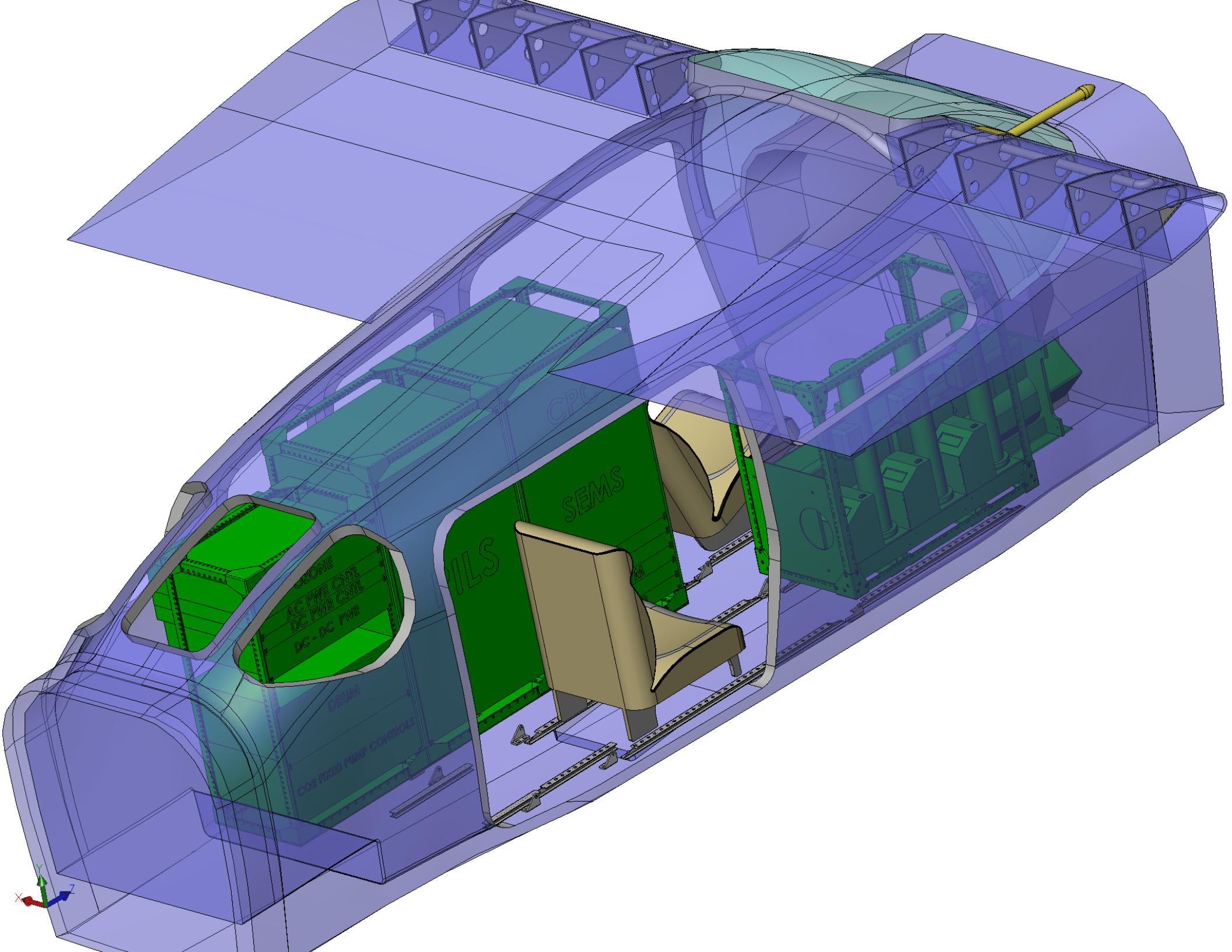

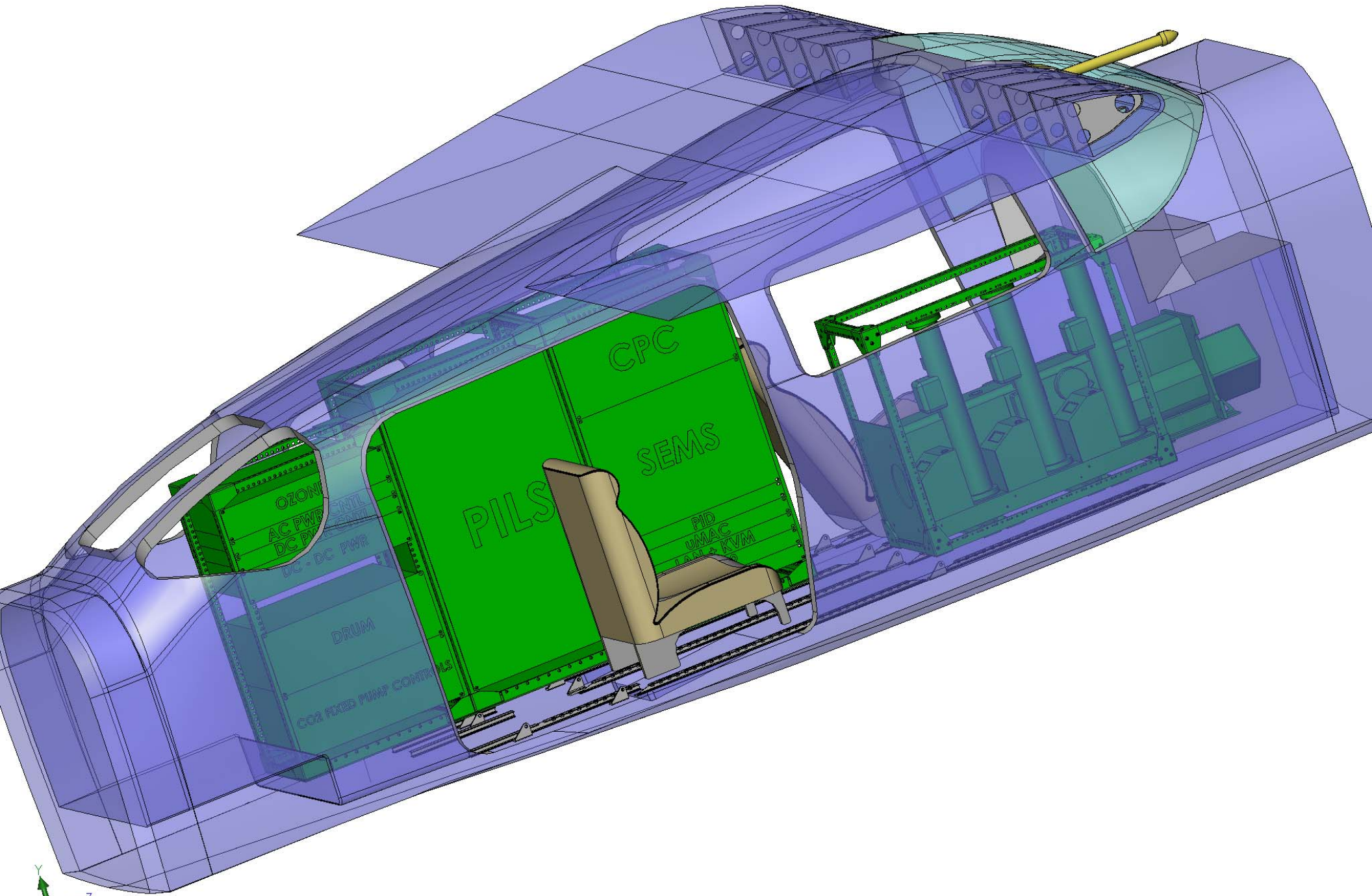

OZON
AC PWR
DC PWR
DC-DC PWR

DRUM
CO2 FIXED PUMP CONTROLS

CPC
SEMS
PILS

PID
UMAC
LALS KVM

